

# DXG2CH50A-450EF

## RF Power GaN Transistor

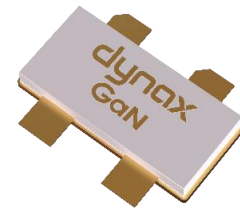

### 1. Product profile

#### 1.1 General description

DXG2CH50A-450EF is a 450 W RF GaN HEMT Transistor with second generation RF GaN technology from Dynax, which is ideal for cellular base station applications at frequencies from 4800 MHz to 5000 MHz.

**Table 1. Typical performance <sup>1</sup>**

Freq (MHz)	P <sub>sat</sub> <sup>2</sup> (dBm)	P <sub>avg</sub> <sup>3</sup> (dBm)	η <sub>D</sub> <sup>3</sup> (%)	G <sub>p</sub> <sup>3</sup> (dB)	ACPR <sup>3</sup> (dBc)
4800	56.6	47.5	42.1	11.3	-29.5/-47.5
4900	56.6	47.5	42.6	11.8	-34.0/-49.5
5000	56.5	47.5	42.2	11.6	-31.0/-47.0

<sup>1</sup> Typical Doherty performance in Dynax Demo with the device soldered onto the heatsink, test condition: V<sub>DS</sub> = 52 V, I<sub>DQA</sub> = 300 mA, V<sub>GSB</sub> = - 4.1 V.

<sup>2</sup> Test condition: Input signal Pulsed CW, Pulse width = 100 μs, Duty cycle = 10 %.

<sup>3</sup> Test condition: Single-Carrier W-CDMA, IQ magnitude clipping, Input signal PAR = 7.5 dB @ 0.01 % probability on CCDF. ACPR measured in 3.84 MHz channel bandwidth @ ±5 MHz offset.

#### 1.2 Features and benefits

- High efficiency, high gain
- Internally matched for broadband performance
- Designed for Digital Pre-Distortion error correction systems
- Optimized for Doherty applications

#### 1.3 Applications

- RF power amplifier for base stations and multi carrier applications in the 4800 MHz to 5000 MHz frequency range

#### 1.4 Lead-free and RoHS compliant



## 2. Pinning information

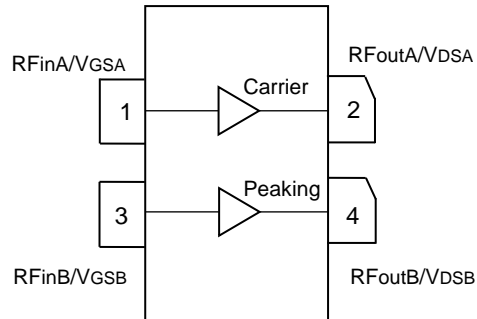

Fig 1. Pin configuration (Top view)

## 3. Ordering information

Table 2. Ordering information

Part number	Marking	Package type	Packaging information
DXG2CH50A-450EF	DXG2CH50A-450EF	780P2GB	Tray: Suffix = 20 units
			Tape and Reel: Suffix = 100 units; 44 mm Tape width; 13-inch Reel

## 4. Maximum ratings

**Table 3. Maximum ratings**

Parameter	Symbol	Rating	Unit
Drain-Source Voltage	$V_{DSS}$	150	V
Gate-Source Voltage	$V_{GS}$	-10 ~ +2	V
Operating Voltage	$V_{DS}$	0 ~ +55	V
Maximum Forward Gate Current	$I_{GMAX}$	65.4	mA
Storage Temperature Range	$T_{STG}$	- 65 ~ +150	°C
Operating Junction Temperature	$T_J$	225	°C
Absolute Maximum Channel Temperature <sup>1</sup>	$T_{MAX}$	275	°C

<sup>1</sup> Functional operation above 225°C has not been characterized and is not implied. Operation at  $T_{MAX}$  (275°C) reduces median time to failure by an order of magnitude; Operation beyond  $T_{MAX}$  could cause permanent damage.

## 5. Thermal characteristics

**Table 4. Thermal characteristics**

Parameter	Symbol	Value	Unit
<b>Side A, Carrier</b>			
Thermal Resistance at Average Power by Infrared Measurement, Active Die Surface-to-Case $T_{base-plate} = 85^{\circ}C, P_D = 56.8 W$	$R_{thjc}(IR)$	1.3	°C/W
Thermal Resistance at Average Power by Finite Element Analysis, Junction-to-Case $T_{base-plate} = 85^{\circ}C, P_D = 56.8 W$	$R_{thjc}(FEA)$	1.7	°C/W
<b>Side B, Peaking</b>			
Thermal Resistance at Average Power by Infrared Measurement, Active Die Surface-to-Case $T_{base-plate} = 85^{\circ}C, P_D = 14.2 W$	$R_{thjc}(IR)$	0.7	°C/W
Thermal Resistance at Average Power by Finite Element Analysis, Junction-to-Case $T_{base-plate} = 85^{\circ}C, P_D = 14.2 W$	$R_{thjc}(FEA)$	0.9	°C/W

## 6. Electrical characteristics (TA = 25°C unless otherwise noted)

**Table 5. DC characteristics**

Parameter	Symbol	Min.	Typ.	Max.	Unit
<b>Side A, Carrier</b>					
Drain-Source Leakage Current (V <sub>GS</sub> = -10 V, V <sub>DS</sub> = 150 V)	I <sub>DSS</sub>	-	-	23.2	mA
Drain-Source Breakdown Voltage (V <sub>GS</sub> = -10 V, I <sub>D</sub> = 23.2 mA)	V <sub>(BR)DSS</sub>	150	-	-	V
Gate Threshold Voltage (V <sub>DS</sub> = 48 V, I <sub>D</sub> = 23.2 mA)	V <sub>GS(th)</sub>	-4.0	-2.6	-1.0	V
Gate Quiescent Voltage (V <sub>DS</sub> = 48 V, I <sub>D</sub> = 300 mA)	V <sub>GS(Q)</sub>	-	-2.4	-	V
<b>Side B, Peaking</b>					
Drain-Source Leakage Current (V <sub>GS</sub> = -10 V, V <sub>DS</sub> = 150 V)	I <sub>DSS</sub>	-	-	42.2	mA
Drain-Source Breakdown Voltage (V <sub>GS</sub> = -10 V, I <sub>D</sub> = 42.2 mA)	V <sub>(BR)DSS</sub>	150	-	-	V
Gate Threshold Voltage (V <sub>DS</sub> = 48 V, I <sub>D</sub> = 42.2 mA)	V <sub>GS(th)</sub>	-4.0	-2.6	-1.0	V
Gate Quiescent Voltage (V <sub>DS</sub> = 48 V, I <sub>D</sub> = 500 mA)	V <sub>GS(Q)</sub>	-	-2.4	-	V

**Table 6. Load mismatch**

Parameter	Result
VSWR 10:1 at V <sub>DS</sub> = 52 V, 56.2 W WCDMA output power.	No device damage

## 7. Test information

### 7.1 Typical application circuit

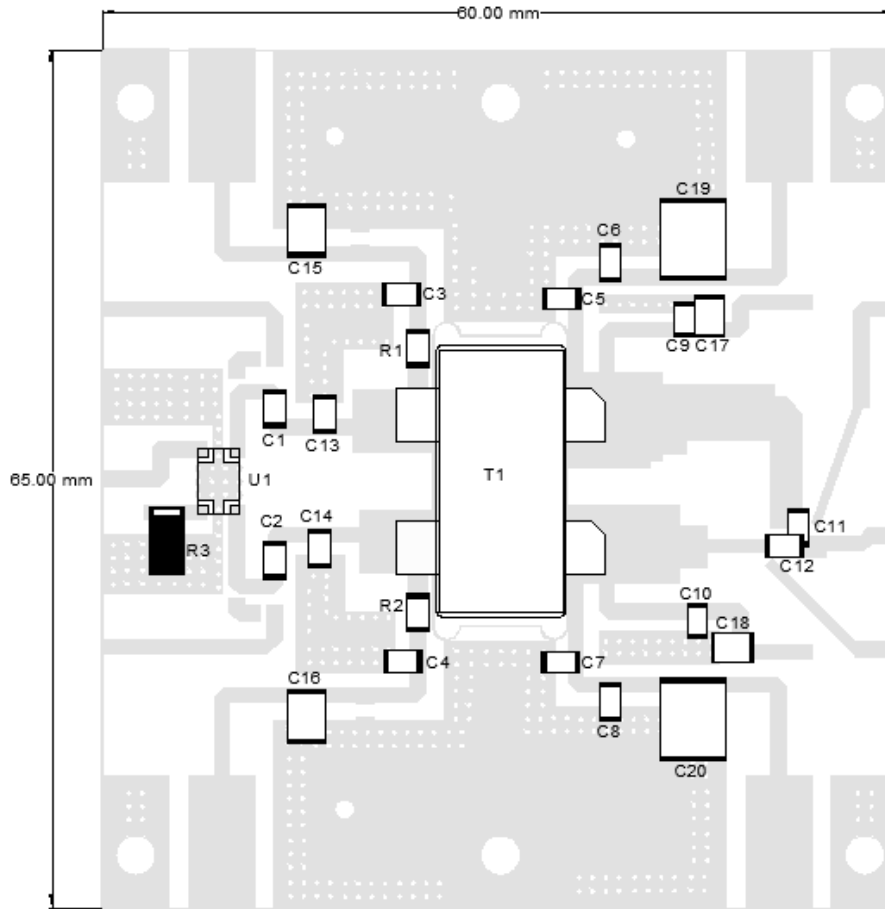

Fig 2. Component layout

Table 7. List of components

S/N	Type	Designator	Description	Value	Vendor
1	Cap	C1~C11	ATC600F3R9JT250XT	3.9 pF	ATC
2	Cap	C12	ATC600F1R0JT250XT	1.0 pF	ATC
3	Cap	C13	ATC600F0R6JT250XT	0.6 pF	ATC
4	Cap	C14	ATC600F0R9JT250XT	0.9 pF	ATC
5	Cap	C15~C18	GRM32ER72A225KA35L	2.2 uF	Murata
6	Cap	C19~C20	C5750X7S2A106KT	10.0 uF	TDK
7	Res	R1,R2	RC1206FR_10R0	10 $\Omega$	Yageo
8	Termination	R3	S1020A	50 $\Omega$	RN2
9	HyBrid coupler	U1	CMX45E03	3 dB	RN2
10	Transistor	T1	DXG2CH50A-450EF	/	Dynax
11	PCB		Rogers 4350B	20 mil	Rogers

## 7.2 Graphic data

### 7.2.1 Pulsed CW

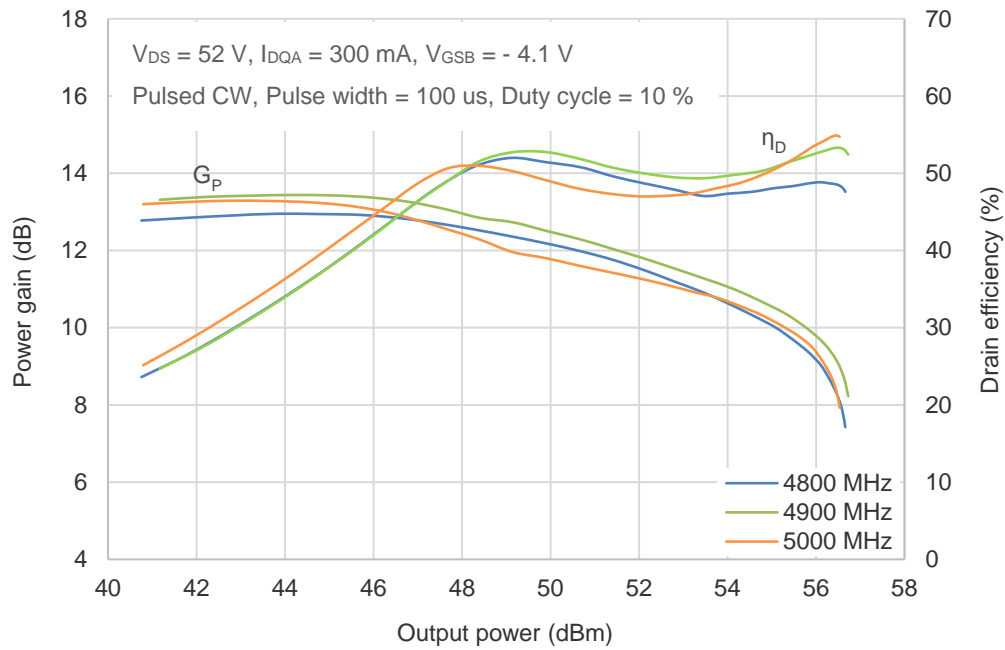

Fig 3. Power gain, Drain efficiency vs. Pulse output power

## 8. Impedance information

**Table 8. Typical impedance of carrier <sup>1</sup>**

Maximum Output Power						
Freq (MHz)	$Z_S$ ( $\Omega$ )	$Z_L$ ( $\Omega$ )	$G_P$ (dB)	$P_{sat}$ (dBm)	$P_{sat}$ (W)	$\eta_D$ (%)
5000	$18.2 + j1.2$	$3.6 - j2.4$	17.2	53.0	200	58.9
Maximum Drain Efficiency						
Freq (MHz)	$Z_S$ ( $\Omega$ )	$Z_L$ ( $\Omega$ )	$G_P$ (dB)	$P_{sat}$ (dBm)	$P_{sat}$ (W)	$\eta_D$ (%)
5000	$18.2 + j1.2$	$5.4 - j0.4$	17.8	51.9	154	63.6

**Table 9. Typical impedance of peaking <sup>2</sup>**

Maximum Output Power						
Freq (MHz)	$Z_S$ ( $\Omega$ )	$Z_L$ ( $\Omega$ )	$G_P$ (dB)	$P_{sat}$ (dBm)	$P_{sat}$ (W)	$\eta_D$ (%)
5000	$20.8 - j0.4$	$3.6 - j0.8$	16.1	55.1	323	55.8
Maximum Drain Efficiency						
Freq (MHz)	$Z_S$ ( $\Omega$ )	$Z_L$ ( $\Omega$ )	$G_P$ (dB)	$P_{sat}$ (dBm)	$P_{sat}$ (W)	$\eta_D$ (%)
5000	$20.8 - j0.4$	$5.0 + j0.9$	16.7	54.5	282	60.6

<sup>1</sup>  $V_{DS} = 48$  V,  $I_{DQA} = 300$  mA, Pulsed CW, Pulse width = 100  $\mu$ s, Duty cycle = 10 %.

<sup>2</sup>  $V_{DS} = 48$  V,  $I_{DQB} = 500$  mA, Pulsed CW, Pulse width = 100  $\mu$ s, Duty cycle = 10 %.

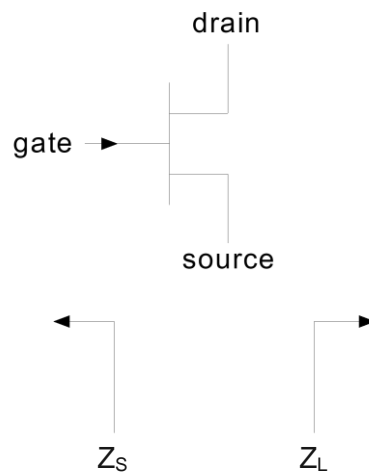

**Fig 4. Definition of transistor impedance**

## 9. Median lifetime

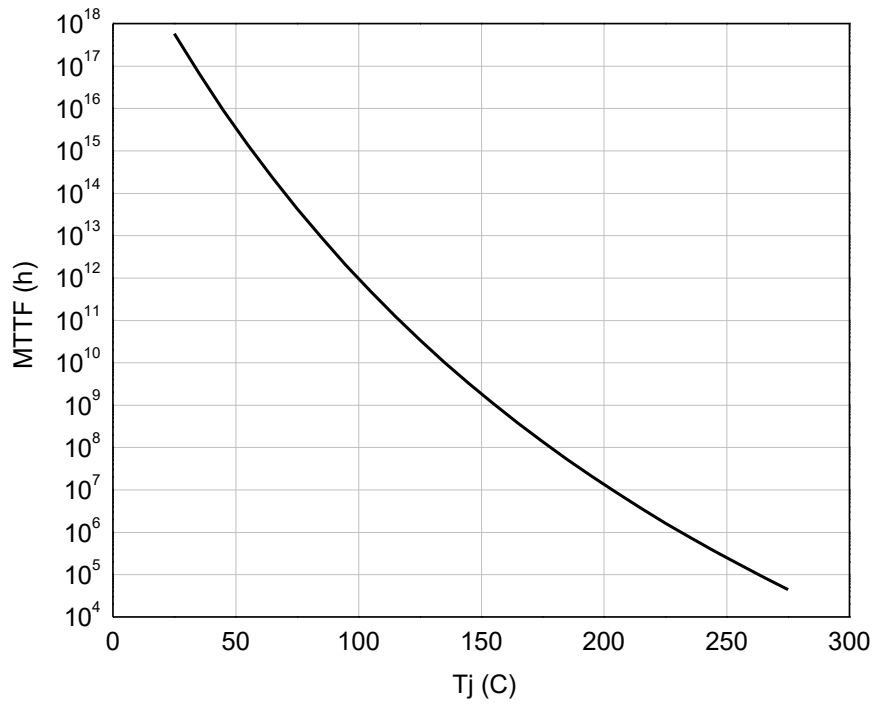

Fig 5. Median lifetime vs. channel temperature



## 10. Package outline

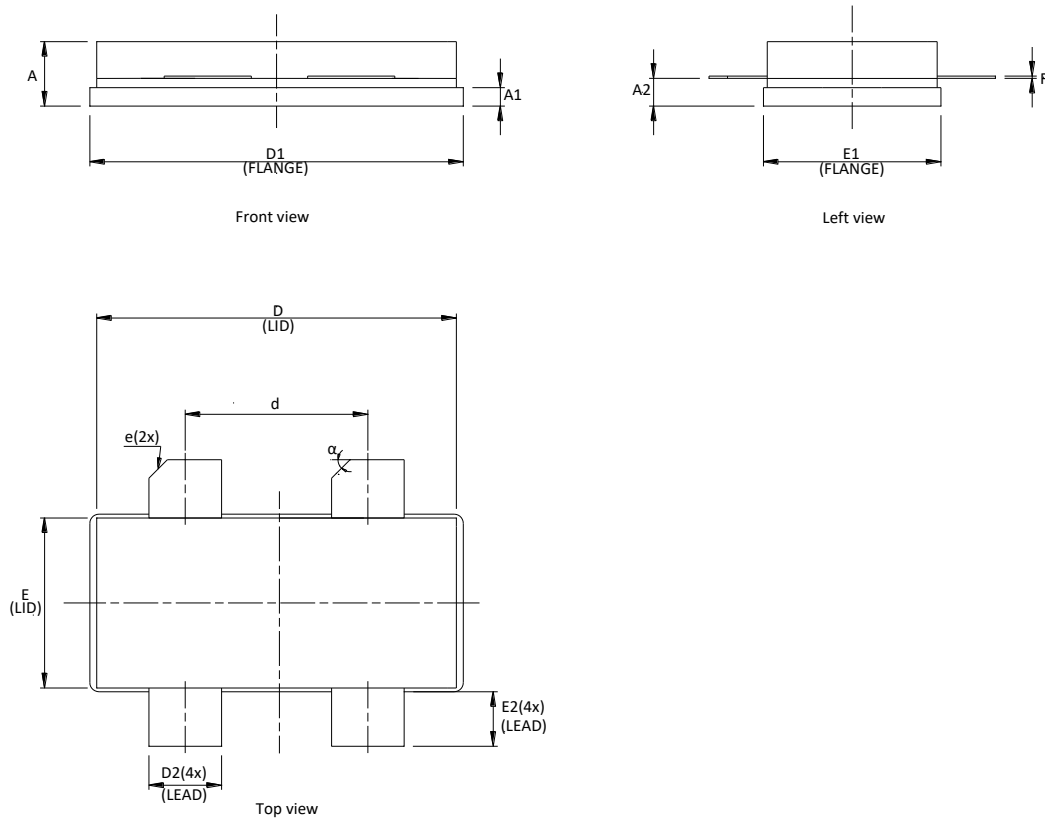

Fig 6. Package outline — 780P2LB

Table 10. Package dimensions

DIM	INCH			MILLIMETER		
	MIN	NOM	MAX	MIN	NOM	MAX
A	0.134	0.144	0.154	3.40	3.65	3.90
A1	0.035	0.040	0.045	0.89	1.02	1.14
A2	0.057	0.062	0.067	1.45	1.58	1.70
D1	0.805	0.810	0.815	20.45	20.58	20.70
D2	0.153	0.158	0.162	3.87	4.00	4.13
d	0.385	0.390	0.395	9.77	9.90	10.03
D	0.772	0.780	0.788	19.61	19.82	20.02
E	0.365	0.370	0.375	9.27	9.40	9.53
E1	0.380	0.385	0.390	9.65	9.78	9.91
E2	0.098	0.118	0.138	2.50	3.00	3.50
F	0.003	0.005	0.006	0.08	0.12	0.15
e	TYP 0.04			TYP 1.02		
$\alpha$	45° REF			45° REF		

## 11. Abbreviations

**Table 11. Abbreviations**

Acronym	Description
CW	Continuous Waveform
ESD	Electro-Static Discharge
GaN	Gallium Nitride
HEMT	High Electron Mobility Transistor
MTTF	Median Time To Failure
VSWR	Voltage Standing Wave Ratio

## 12. Legal information

### 12.1 Datasheet status

Document status	Product status	Definition
Objective [short] datasheet	Engineering sample	This document contains data from the objective specification for product development.
Preliminary [short] datasheet	Engineering sample	This document contains data from the preliminary specification.
Production [short] datasheet	Mass product	This document contains the product specification.

### 12.2 Definitions

**Draft** — The document is a draft version only. The content is still under internal review and subject to formal approval, which may result in modifications or additions. Dynax does not give any representations or warranties as to the accuracy or completeness of information included herein and shall have no liability for the consequences of use of such information.

**Short datasheet** — A short datasheet is an extract from a full datasheet with the same product type number(s) and title. A short datasheet is intended for quick reference only and should not be relied upon to contain detailed and full information. For detailed and full information see the relevant full datasheet, which is available on request via the local Dynax sales office. In case of any inconsistency or conflict with the short datasheet, the full datasheet shall prevail.

**Product specification** — The information and data provided in a Product datasheet shall define the specification of the product as agreed between Dynax and its customer, unless Dynax and customer have explicitly agreed otherwise in writing. In no event however, shall an agreement be valid in which the Dynax product is deemed to offer functions and qualities beyond those described in the Product datasheet.

### 12.3 Disclaimers

Information in this document is believed to be accurate and reliable. However Dynax does not give any representations or warranties, expressed or implied, as to the accuracy or completeness of such information and shall have no liability for the consequences of use of such information. Dynax takes no responsibility for the content in this document if provided by an information source outside of Dynax.

All information contained herein is subject to change without notice. Customers should obtain and verify the latest relevant information before placing orders for Dynax products.

The information contained herein or any use of such information does not grant, explicitly or implicitly, to any party any patent rights, licenses, or any other intellectual property rights, whether with regard to such information itself or anything described by such information.

Applications that are described herein for any of these products are for illustrative purposes only. Dynax makes no representation or warranty that such applications will be suitable for the specified use without further testing or modification. Customers are responsible for the design and operation of their applications and products using Dynax products, and Dynax accepts no liability for any assistance with applications or customer product design. It is customer's sole responsibility to determine whether the Dynax product is suitable and fit for the customer's applications and products planned, as well as for the planned application and use of customer's third party customer(s). Customers should provide appropriate design and operating safeguards to minimize the risks associated with their applications and products.

Dynax products are not designed, authorized or warranted to be suitable for use in life support, life-critical or safety-critical systems or equipment, nor in applications where failure or malfunction of a Dynax product can reasonably be expected to result in personal injury, death or severe property or environmental damage.

Unless this datasheet expressly states that this specific Dynax product is automotive qualified, the product is not suitable for automotive use. It is neither qualified nor tested in accordance with automotive testing or application requirements.

This document as well as the item(s) described herein may be subject to export control regulations. Export might require a prior authorization from competent authorities.

## 13. Contact information

For more information, please visit: <http://www.dynax-semi.com>